

共第70号 わかめ漁業
 あわび漁業
 さざえ漁業
 つに漁業
 なまこ漁業

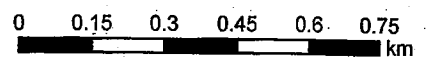

N
 1:15,000

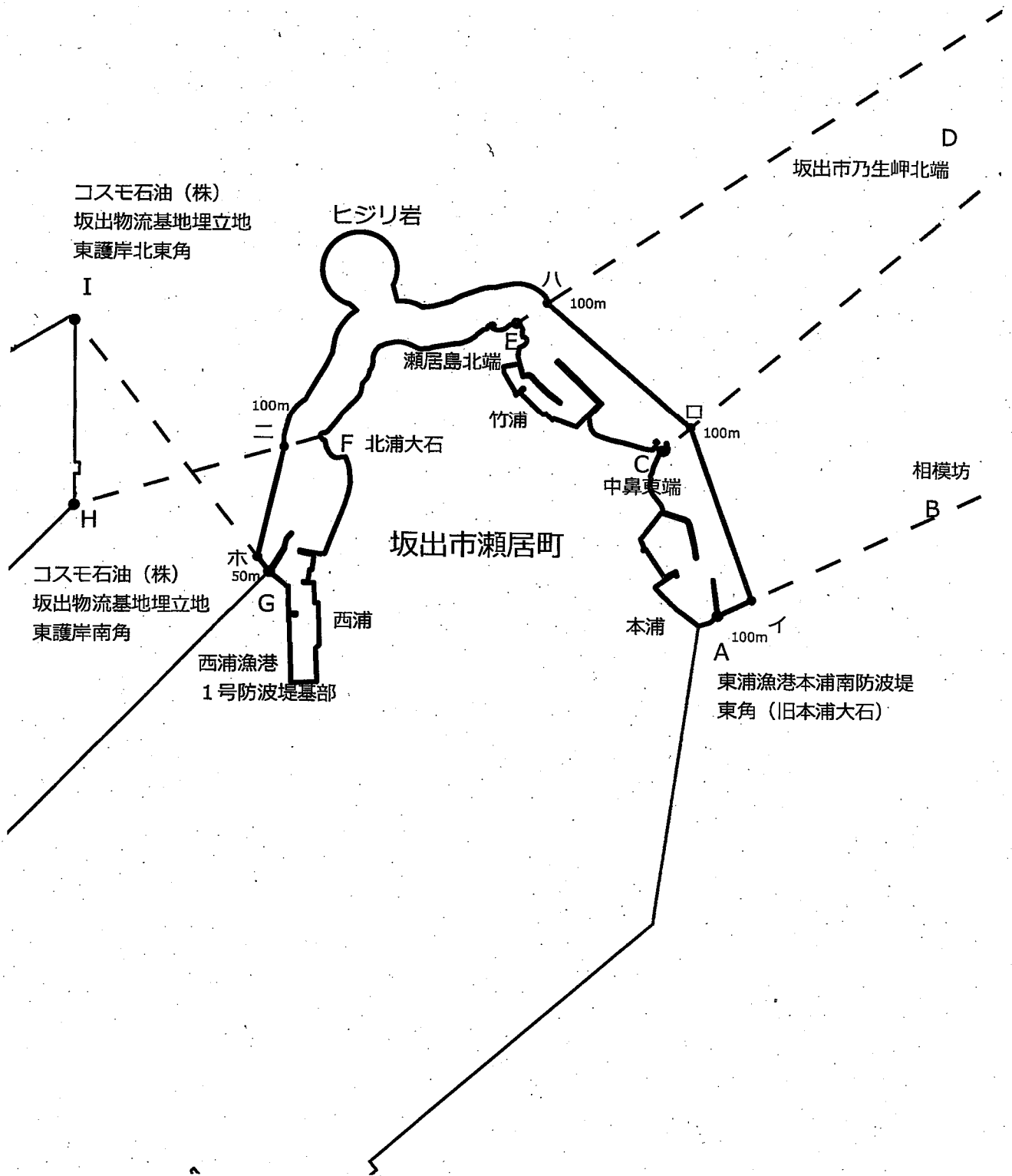

共第71号

わかめ漁業
あわび漁業
さざえ漁業
うに漁業
なまこ漁業



1:15,000

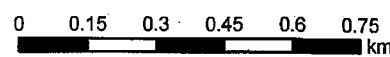
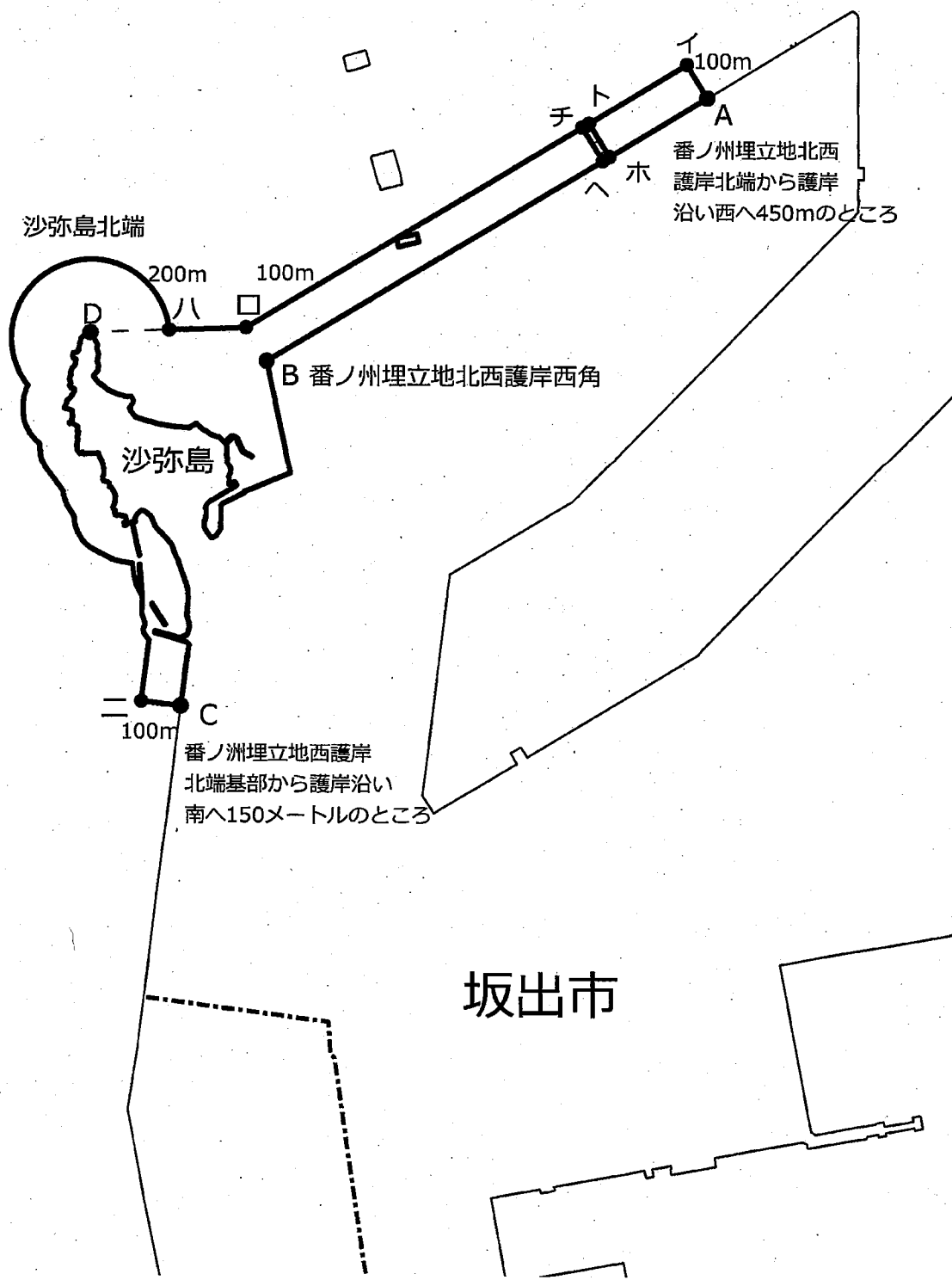

共第72号

わかめ漁業
あわび漁業
さざえ漁業
うに漁業
なまこ漁業

N
1:25,000

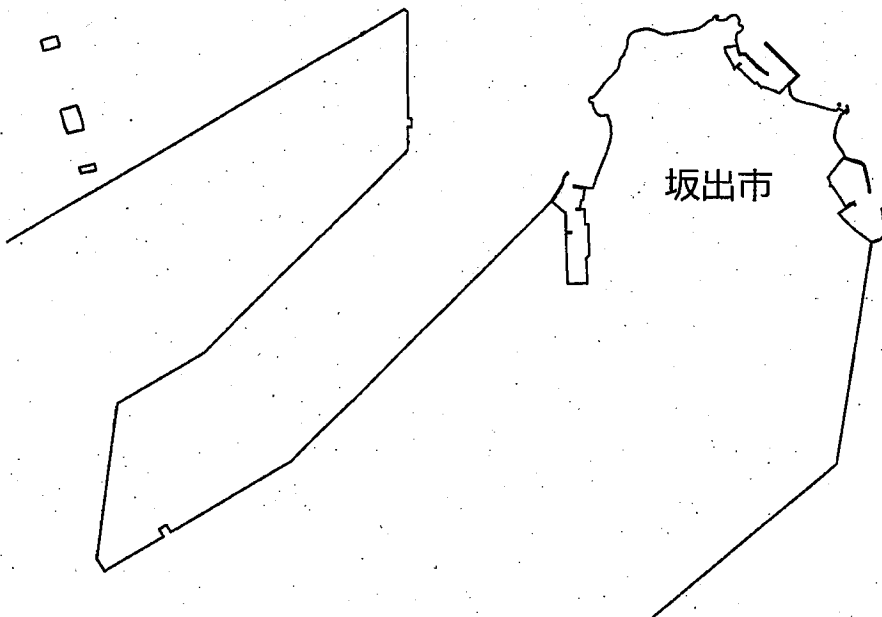

0 0.25 0.5 0.75 1 1.25 km

共第73号

わかめ漁業
あわび漁業
さざに漁業
なまこ漁業

坂出市与島

N
1:10,000

100m

三ツ子島

100m

4 A

0 0.1 0.2 0.3 0.4 0.5 km

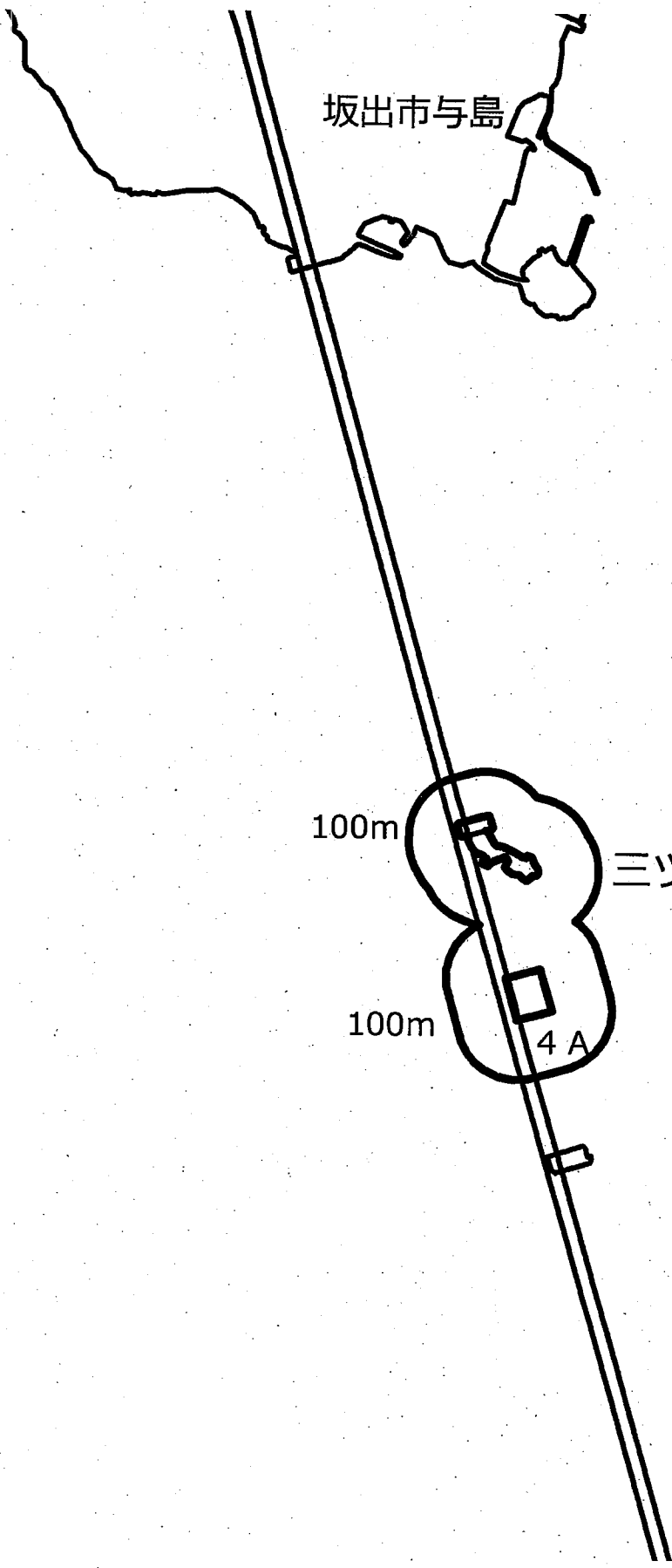

共第74号 わかめ漁業
あわび漁業
さざえ漁業
うに漁業
なまこ漁業

N
1:15,000

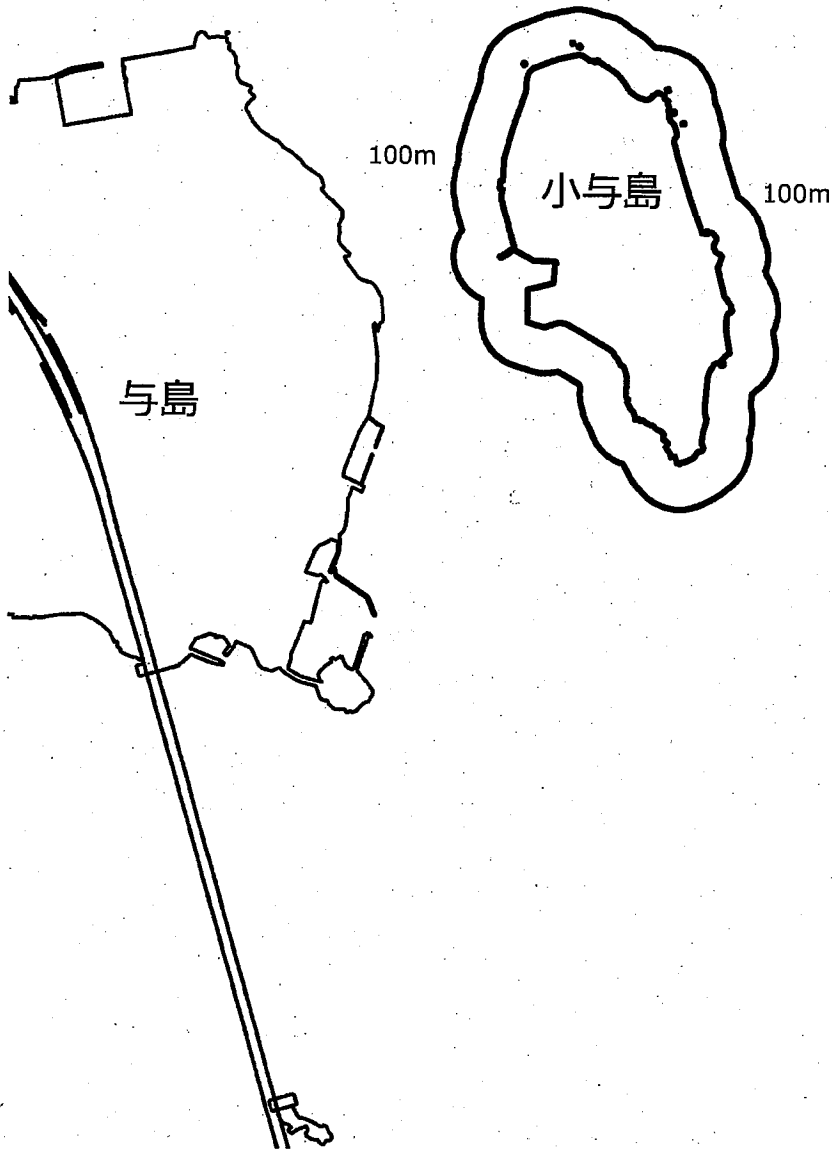

0 0.15 0.3 0.45 0.6 0.75 km

共第75号

わかめ漁業
あわび漁業
さざえ漁業
うに漁業
なまこ漁業

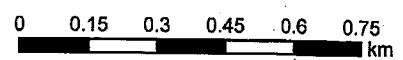
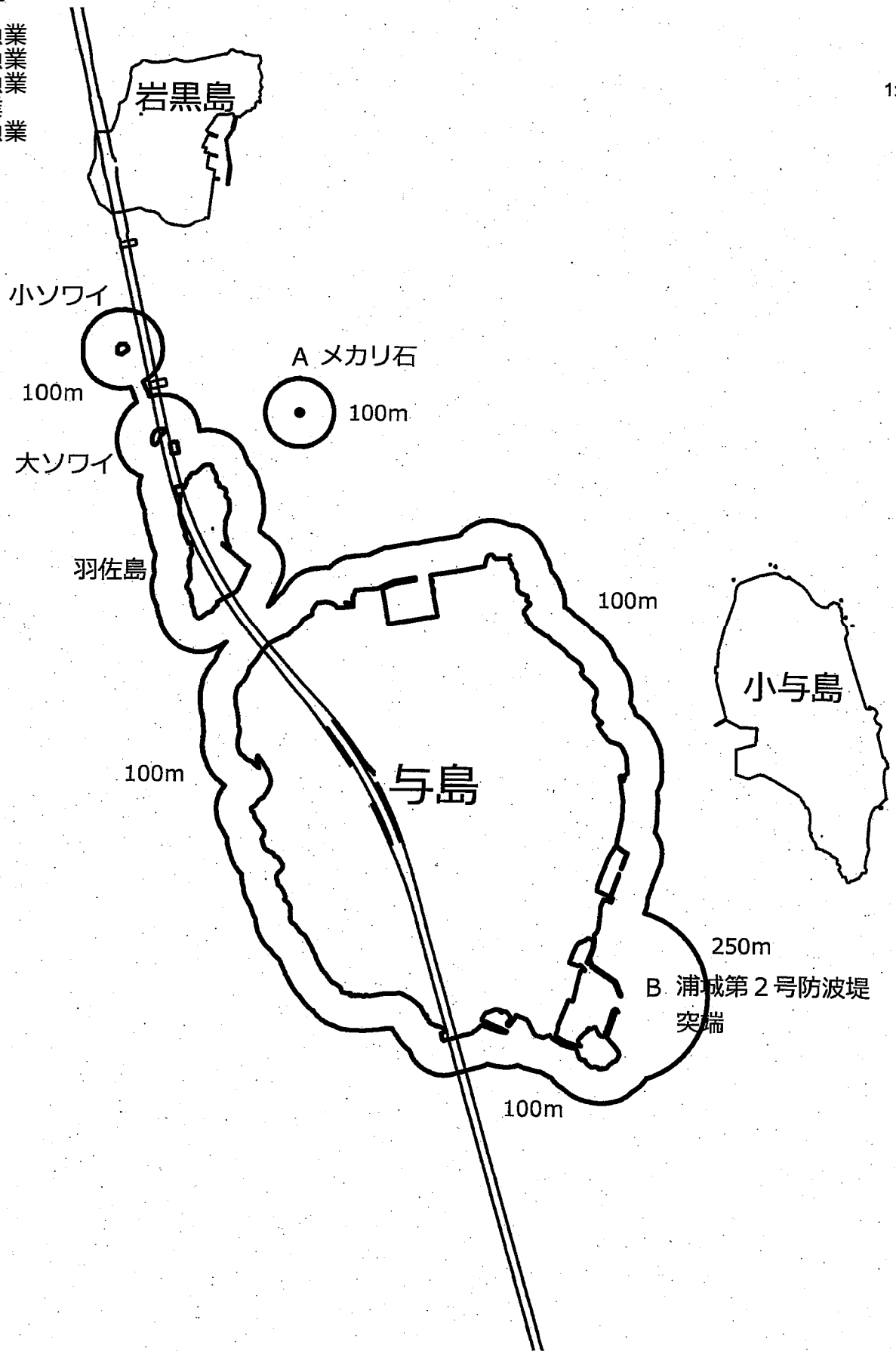

わかめ漁業
あわび漁業
さざえ漁業
つに漁業
なまこ漁業
共第76号

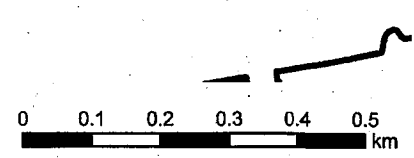
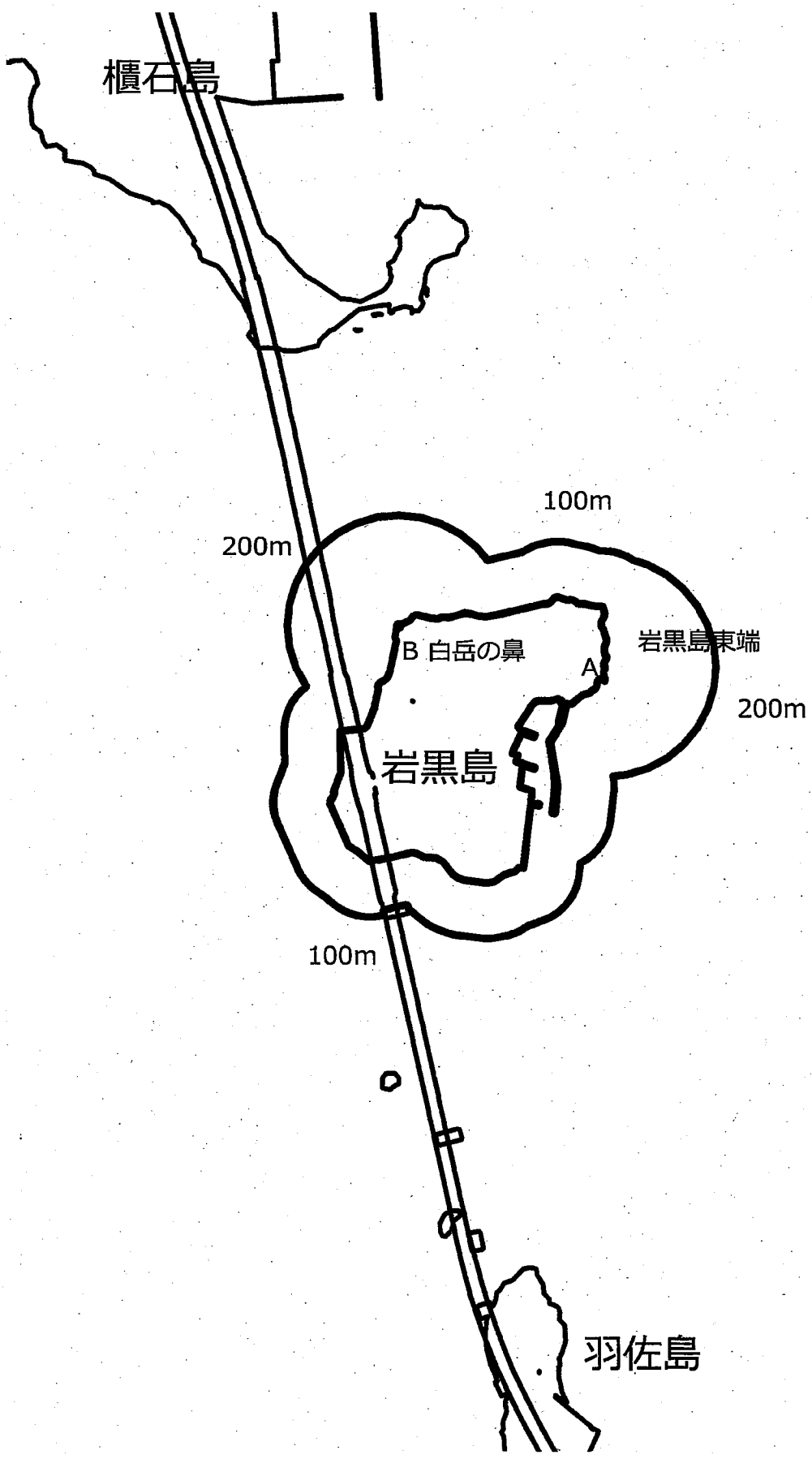

共第77号

わかめ漁業
あわび漁業
さざえ漁業
なまこ漁業

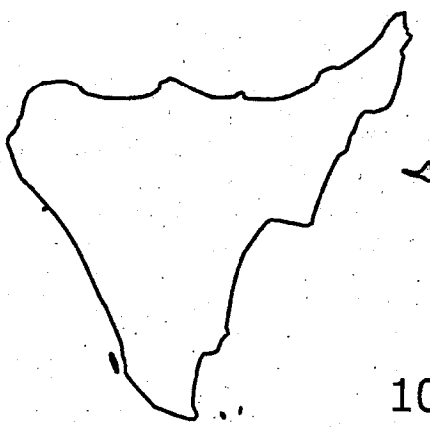

100m



室木島



1:15,000

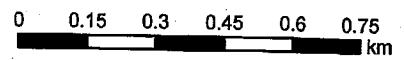

わかめ漁業
あわび漁業
さざえ漁業
つに漁業
なまこ漁業
共第78号

N
1:15,000



大裸島

100m

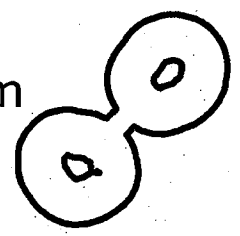

小裸島

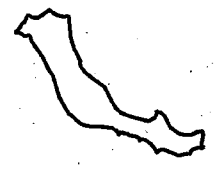
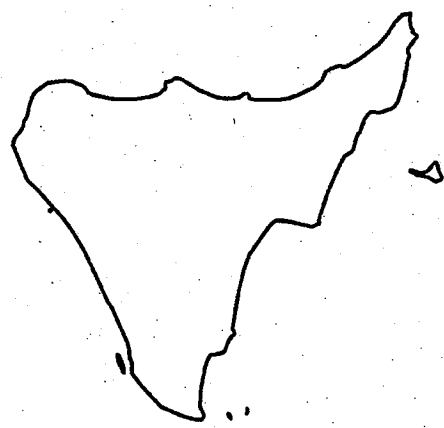

0 0.15 0.3 0.45 0.6 0.75 km

共第79号

わかめ漁業
あわび漁業
さざえ漁業
うに漁業
なまこ漁業

